

SANYO	No. 2824A	LA4165M
Recording/Playback IC for Micro-Cassette Tape Recorder		

Overview

The LA4165M Recording/Playback IC combines the functions required to design the recording and playback systems and motor control circuits for micro- or standard-cassette tape recorders into a single chip.

Functions provided include automatic audio input sensing during recording with stepless setting of the on/off threshold using the playback volume control, and LED indication that recording is in progress.

Recording and playback modes can be toggled using a single control pin.

The LA4165M also has an on-chip preamp, power amp and ALC circuits, and has been designed to operate with a 3V power supply. The device is available in 24-pin plastic MFPs.

Features

- Audio input sensor circuit
- LED driver circuit
- Motor control circuit
- ALC circuit
- Preamp and power amp circuits

Maximum Ratings at Ta = 25°C

Maximum Supply Voltage	V_{CC} max		4.5	V
Allowable Power Dissipation	P_d max	$G_{VN} + \text{Power}$	1100	mW
Operating Temperature	T_{op}		- 10 to + 50	°C
Storage Temperature	T_{stg}		- 55 to + 150	°C

Operating Conditions at Ta = 25°C

Recommended Supply Voltage	V_{CC}		3	V
Operating Voltage Range	V_{CC} op		1.8 to 3.6	V
Power Amp Load Resistance	$R_{L PWR}$	PLAY	4	Ω
		REC	10	kΩ
Preamp Load Resistance	$R_{L PRE}$		10	kΩ

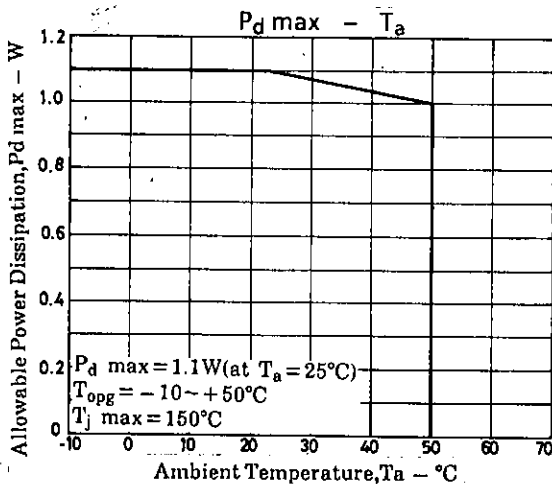

Package Dimensions 3108 (unit:mm)

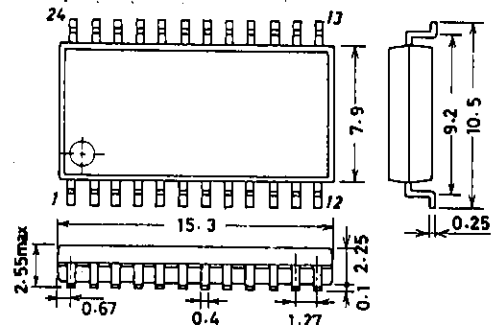

SANYO: MFP24D 375mil

LA4165M

Operating Characteristics at		$T_a = 25^\circ\text{C}, V_{CC} = 3.0\text{V}, R_L = 4\Omega(\text{Play Power}), R_L = 10\text{k}\Omega(\text{Rec Power}),$ $R_L = 10\text{k}\Omega(\text{Pre}), f = 1\text{kHz}, 0\text{dBm} = 0.775\text{V}$				
			min	typ	max	unit
[Pre + Power]						
Quiescent Current	I_{CC-R}	REC mode, $V_i = 0\text{V}$	12	25	38	mA
Quiescent Current	I_{CC-P}	PLAY mode, $V_i = 0\text{V}$	13	26	39	mA
Voltage Gain (Closed Loop) REC	$V_{G_{TR}}$	REC mode, $V_o = -5\text{dBm}$	62	64.5	67	dB
Voltage Gain (Closed Loop) PLAY	$V_{G_{TP}}$	PLAY mode, $V_o = -5\text{dBm}$	71	73.5	76	dB
[Pre Amp]						
Voltage Gain (Closed Loop) REC	$V_{G1 R}$	REC mode, $V_o = -10\text{dBm}$, $R_{NF} = 100\Omega$	32.5	35	37.5	dB
Voltage Gain (Closed Loop) PLAY	$V_{G1 P}$	PLAY mode, $V_o = -10\text{dBm}$, $R_{NF} = 100\Omega$	42.5	45	47.5	dB
Maximum Output Voltage	$V_o \text{ max}$	THD = 1%, PLAY mode	0.3	0.6	1.0	V
Equivalent Input Noise Voltage	V_{NI}	PLAY mode, BPF = 20Hz to 20kHz	0.5	1.1	2.0	μV
Input Resistance	R_i		22.5	32.2	42	k Ω
Total Harmonic Distortion	THD1	PLAY mode, $V_o = 0.4\text{V}$	0.01	0.11	1.0	%
[Power Amp]						
Voltage Gain	V_{G2}	$V_o = -5\text{dBm}, R_L = 4\Omega$	26.0	28.5	31.0	dB
Output Power	P_o	THD = 10%, $R_L = 4\Omega$	180	215	350	mW
Total Harmonic Distortion	THD2	$P_o = 30\text{mW}, R_L = 4\Omega$	0.05	0.5	1.5	%
Output Noise Voltage	V_{NO}	$R_V = 0, R_L = 4\Omega, \text{BPF} = 20\text{Hz to } 20\text{kHz}$	5	25	100	μV
[ALC]						
ALC Width	ALC W	Input voltage above ALC cut-in voltage for ALC output to rise by 2.5dB	30	38	45	dB
ALC Distortion	ALC THD	Pre: $V_i = -40\text{dBm}$	0.1	0.67	1.5	%
ALC Output	ALC V_o	Pre: $V_i = -40\text{dBm}$	0.35	0.46	0.55	V
ALC Start Input Level	ALC V_{IN}		-66.5	-69	-71.5	dBm
[Voice Sensor]						
Minimum Activation Input Voltage	$V_{op \text{ min}}$	VR (10k Ω) max	-84.5	-81.5	-78.5	dBm
Maximum Activation Input Voltage	$V_{op \text{ max}}$	VR (10k Ω) max	-62.5	-59.5	-56.5	dBm
Input Hysteresis	V_{oHL}		3	6	9	dB
[LED Drive]						
LED Drive Current	I_{LED}	Red LED	1.0	2.5	4.5	mA
[Motor Control]						
Reference Voltage	V_{ref}	$I_m = 100\text{mA}$	1.1	1.25	1.4	V
Quiescent Current	I_d	$I_m = 100\text{mA}$	2.0	3.0	6.0	mA
Shunt Ratio	K	$I_m = 50-100\text{mA}$	45	50	55	
Residual Voltage	V_{sat}	$I_m = 200\text{mA}, V_{ref} = V_{cont}$	0.1	0.3	0.5	V
Voltage Characteristic of Reference Voltage	$\frac{\Delta V_{ref}}{V_{ref}} / \Delta V_{CC}$	$V_{CC} = 1.8 \text{ to } 4.5\text{V}, I_m = 100\text{mA}$	0	0.1	0.5	%/V
Voltage Characteristic of Shunt Ratio	$\frac{\Delta K}{K} / \Delta V_{CC}$	$V_{CC} = 2.0 \text{ to } 4.5\text{V}, I_m = 50-100\text{mA}$	0	0.1	0.5	%/V
Current Characteristic of Reference Voltage	$\frac{\Delta V_{ref}}{V_{ref}} / \Delta I_m$	$I_m = 50 \text{ to } 200\text{mA}$	0	0.007	0.03	%/mA
Current Characteristic of Shunt Ratio	$\frac{\Delta K}{K} / \Delta I_m$	$I_m = 50-100 \text{ to } 150-200\text{mA}$	-0.05	0.005	0.05	%/mA

LA4165M

Recording/Playback Mode Functions

○ : ON × : OFF

Circuit	Preamp	ALC Circuit	LED Drive	Voice Sensor Circuit	Power Amp	Motor Control
Recording Mode	(MIC Amp) ○	○	○ ※	○ ※	○	○ ※
Playback Mode	(EQ Amp) ○	×	×	×	○	○

※ : Block is on when MIC input voltage exceeds the threshold level.

Test Circuit

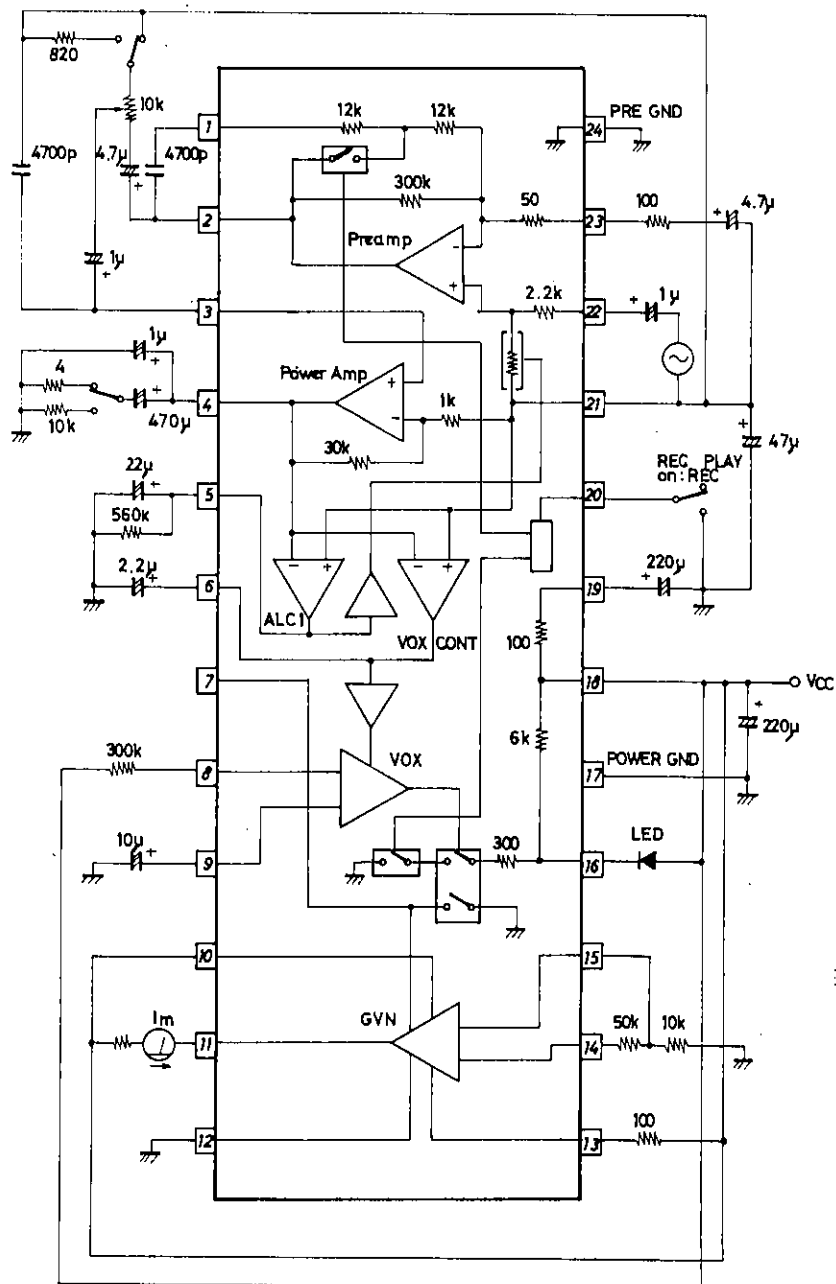

Unit (resistance: Ω, capacitance: F)

LA4165M

Block Diagram

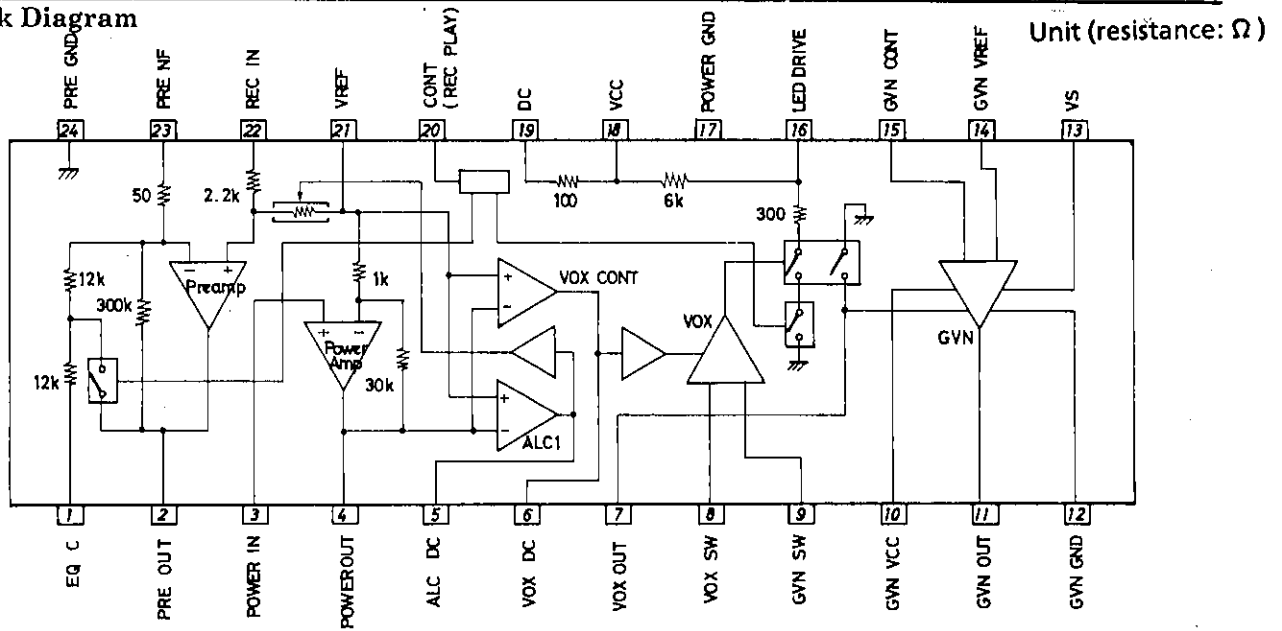

Sample Application Circuit

Voice sensor activation level set. As R2 is reduced, the voice sensor circuit activates at a low input voltage. C1 3900p Sets recording current.

Unit (resistance: Ω , capacitance: F)

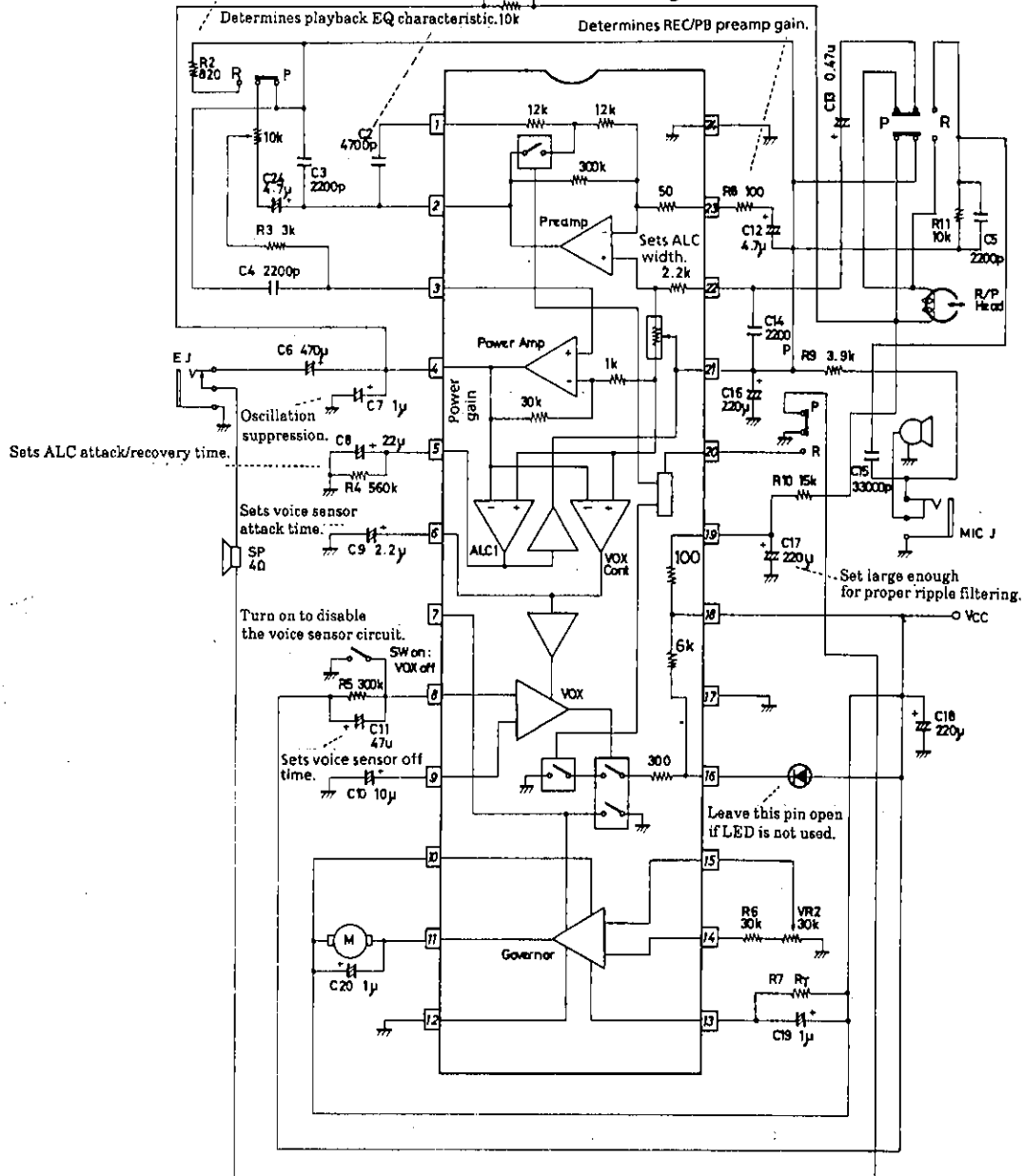

Functional Description
[Preamp]

- The frequency response characteristic of the low noise preamplifier is selected by the record/playback select pin CONT (pin 20). If CONT is taken to ground to select record mode, the frequency response is flat. If CONT is left open, playback mode is selected and the preamp has the NAM response curve.

[Power Amp]

- The power amplifier is suited to driving 4Ω speakers and earphones.

[ALC]

- The ALC (Automatic Level Control) circuit is active in recording mode. It detects the power amp output level, and controls the preamplifier input gain so that the power amp output level is constant.

[VOX CONT VOX]

- This circuit monitors the power amp output level, and turns the motor drive on or off. When the VOX CONT circuit is operating, the LED drive output on pin 16 is active. The LED is extinguished if the supply voltage drops to 1.8V.

[GVN]

- Motor control circuit. The external constants are determined according to the motor characteristics to keep the motor speed constant.

Circuit Components

The function of each component, together with recommended values in parentheses, are listed below.

- C1: (2200 to 4700pF)
Determines the frequency response of the signal voltage to the record/replay head during recording. Its value should be selected according to the characteristics of the head.
- C2: (4700pF)
Determines the playback equalization frequency response.
- C3: (2200pF)
Suppresses high-frequency oscillation.
- C4: (2200 to 4700pF)
Controls high-frequency characteristics. C4 will interact with R3 to reduce the power amp input level if it is too large.
- C5: (2200 to 4700pF)
Microphone input high-frequency filter. This should be selected according to the high-frequency cut-off and the value of C21.
- C6: (470μF)
Couples the power amp output to the speaker or headphones. A value of 220μF is adequate when using an 8Ω speaker or headphones.
- C7: (1μF)
Suppresses oscillation. For low-temperature operation (down to -10°C), a 0.47μF tantalum electrolytic capacitor should be used.
- C8: (22μF)
ALC control smoothing filter. C8 should not be too large, since this will also increase attack time.
- C9: (0.1 to 2.2μF)
Voice sensor (VOX) control smoothing filter. C8 should not be too large, since this will also increase turn-on delay (the time for the motor drive circuit to turn on after the microphone input voltage reaches the set level).

Continued on next page.

Continued from preceding page.

- C10: (10 μ F)
Voice sensor transient suppression. This prevents the motor drive from being turned on by large transient pulses.
- C11: (47 μ F)
Determines the time constant for motor drive hold after the voice sensor circuit turns off. The motor drive remains on for approximately 4 to 5 seconds if the resistor in parallel with R5 is 300k Ω .
- C12: (4.7 μ F)
Together with series resistor R8, determines the preamp low-frequency cut-off. For C12=4.7 μ F and R8=100 Ω , the cut-off is approximately 200Hz. The cut-off can be set to approximately 100 or 300Hz by giving C12 a value of 10 μ F or 2.2 μ F, respectively.
- C13: (0.47 μ F)
Preamp input coupling capacitor.
- C14: (2200pF)
EMI suppression capacitor. Select this according to the characteristics of the record/play head.
- C15: (3300pF)
Microphone input high-frequency filter.
- C16: (220 μ F)
Reference voltage decoupling capacitor.
- C17: (220 μ F)
Head DC supply ripple filter.
- C18: (220 μ F)
Supply decoupling capacitor.
- C19: (1 to 10 μ F)
Reference resistor (R7) bypass capacitor. Setting should be performed according to motor characteristics.
- C20: (1 μ F)
Load (motor) bypass capacitor. Setting should be performed according to motor characteristics.
- R1: (5 to 15k Ω)
Determines the flow of AC current through the head. Select this according to the head characteristics and ALC level.
- R2: (820 Ω)
Determines the microphone input level at which the voice sensor starts operating when VR1 is at minimum. Larger values for R2 give voice sensor operation at lower microphone input signal levels.
- R3: (3k Ω)
Improves high-frequency response and reduces high-frequency distortion. Distortion above 5kHz increases as R3 decreases.
- R4: (100k Ω to 3M Ω)
Determines ALC recovery time.
- R5: (300k Ω)
Voice sensor circuit control current resistor. R5 and C11 form the motor drive hold-time constant.
- R6: (20 to 70k Ω)
Determines motor speed. Select this according to the motor characteristics and the value of variable resistor VR2.

Continued on next page.

Continued from preceding page.

- R7: (100 to 300 Ω)
Select this according to the motor characteristics.
- R8: (0 to 200 Ω)
Preamp negative feedback resistor.
- R9: (3.9k Ω)
Bias set resistor for electrostatic microphones.
The current into or out of the reference voltage pin (pin 21) should not be greater than $\pm 1\text{mA}$, or the bias of other circuits will be affected. In particular, the power amplifier output power will be reduced.
- R10: (15k Ω)
Recording head bias set resistor. Since the bias reference voltage is the filtered DC voltage on pin 19, excessive current should not be drawn by R10, or the reference voltage on pin 21 will be affected. The following diagram shows the internal circuit of the reference voltage generator.

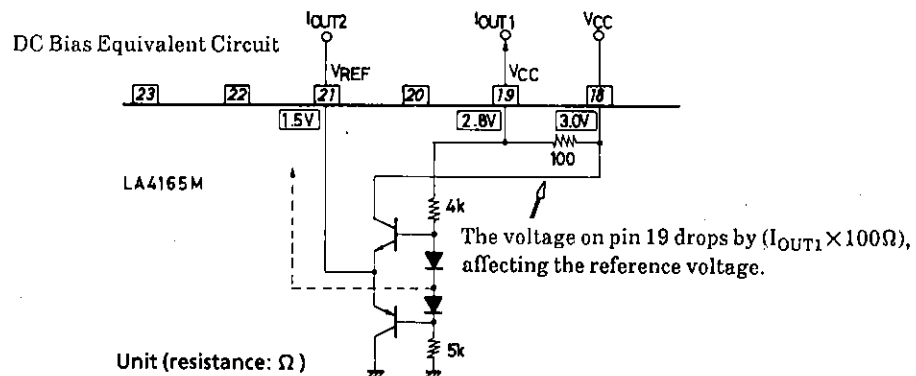

- R11: (5 to 20k Ω)
Select this to match the electrostatic microphone output characteristics.
- VR1: (10 to 30k Ω)
Adjusts the output level in playback mode, and the voice sensor sensitivity in record mode.
- VR2: (5 to 30k Ω)
Motor speed fine adjustment.
- LED: (Red LED)
Illuminated while recording. The LED starts to go out when V_{CC} drops to 2.2V, and is completely extinguished when V_{CC} drops to 1.8V.

LA4165M

Pin No.	Symbol	Pin Name	Voltage [V]
1	V _{EQC}	Equalizer C	1.5
2	V _{PRE OUT}	Pre out	1.5
3	V _{PWR IN}	Power in	1.5
4	V _{OUT}	Power out	1.5
5	ALC	Auto Level Cont	0
6	VOX CONT	Voice Ope Cont	0
7	VOX SW	Voice Ope Switch	3.0
8	VOX RECOV	Voice Ope Recorder	0
9	VOX C	Voice Ope C	0
10	V _{CC}	GVN V _{CC}	3.0
11	V _{OUT} GVN	GVN out	
12	GND GVN	GVN GND	0
13	V _{SGVN}	V _{SGVN}	
14	V _{REF} GVN	GVN V _{REF}	1.2
15	GVN CONT	GVN Cont	
16	LED	LED Drive	
17	GND	Power GND	0
18	V _{CC}	V _{CC}	3.0
19	R.F	Ripple Filter	2.8
20	R/P CONT	REC/PLAY Cont	3.0
21	V _{REF}	V _{REF}	1.5
22	IN	Pre in	1.5
23	NF	Pre NF	1.5
24	GND	Pre GND	0

Design Notes

1. Locate the LC4165M as close as possible to the power source, to prevent voltage and power loss due to supply line resistance.

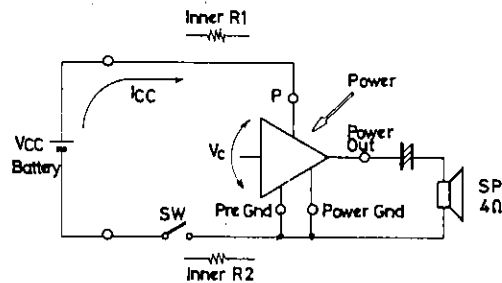

Change "Inner R₁" to "Wiring resistance R₁"

Change "Inner R₂" to "Wiring resistance R₂"

The total wiring resistance $R_T = R_1 + R_2$ causes the voltage V_C at the IC supply pins to drop from the source voltage V_{CC} to

$$V_C = V_{CC} - I_{CC}(R_1 + R_2)$$

The power output from the amplifier is equal to

$$P_o \propto (V_C)^2$$

LA4165M

2. Keep the supply lines for the amplifier circuits separate from those for the motor drive circuit. This will reduce the effect of motor noise on the amplifiers and help prevent voltage drop due to motor load from affecting the amplifier supply voltage.

The recommended supply layout for the LA4165M power supply lines is shown below.

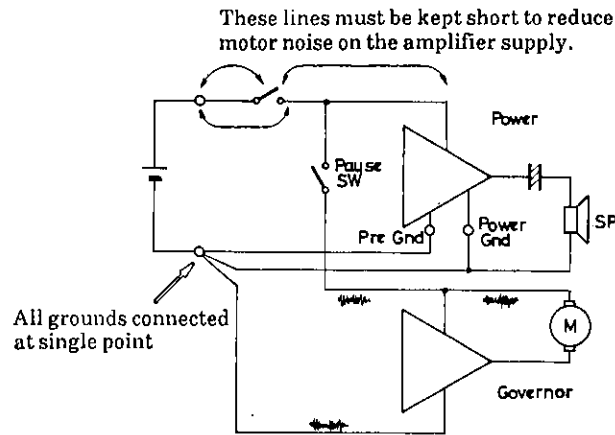

3. Do not connect a resistor to pin 6. The capacitor on this pin is being charged by a small current to determine the voice sensor attack time. Bypassing this capacitor with a resistor will increase attack time, and possibly prevent the voice sensor circuit from turning on.

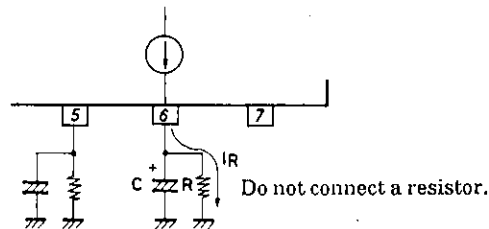

4. The voice sensor circuit has approximately 6dB hysteresis. It turns on at a voltage on pin 6 of approximately 1.1V and turns off at approximately 0.65V. Biasing pin 6 higher than 0.65V will cause it to remain on. The voice sensor equivalent circuit is shown below.

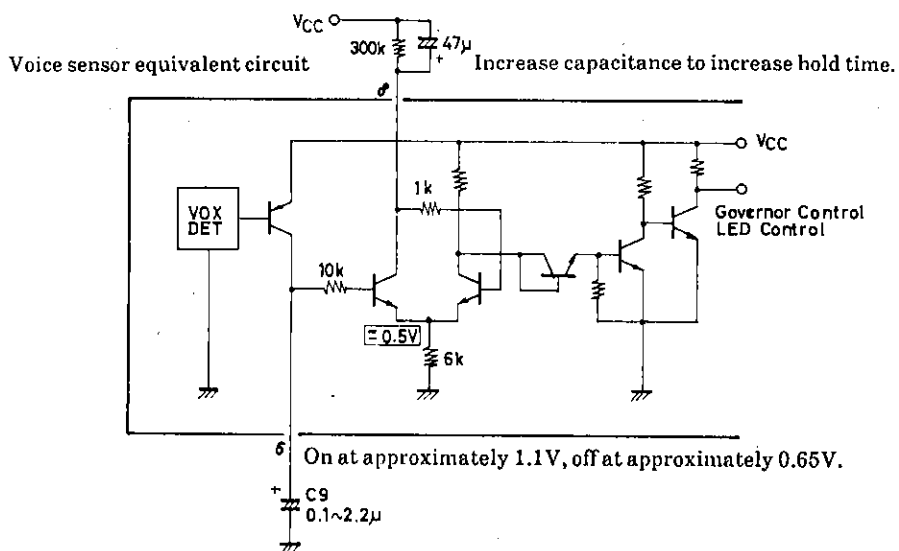

Unit (resistance: Ω, capacitance: F)

LA4165M

5. In record mode, grounding pin 8 will turn off the voice sensor circuit and keep the motor drive circuit operating continuously.

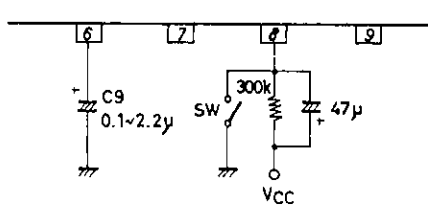

Unit (resistance: Ω , capacitance: F)

6. Pin 7 is close to 0V when the governor circuit is on, and close to V_{CC} when it is off. The voice sensor output stage equivalent circuit is shown below.

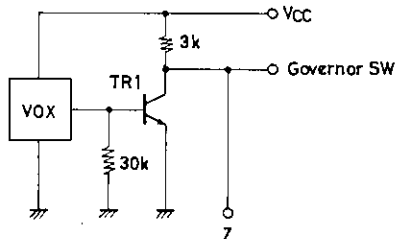

Unit (resistance: Ω)

7. Pin 16 is used solely for driving an external LED, and should be left open when an LED is not used. It is active only during record mode while the motor drive is on. The LED drive circuit is shown below.

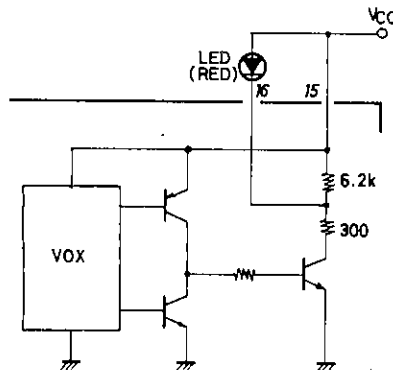

Unit (resistance: Ω)

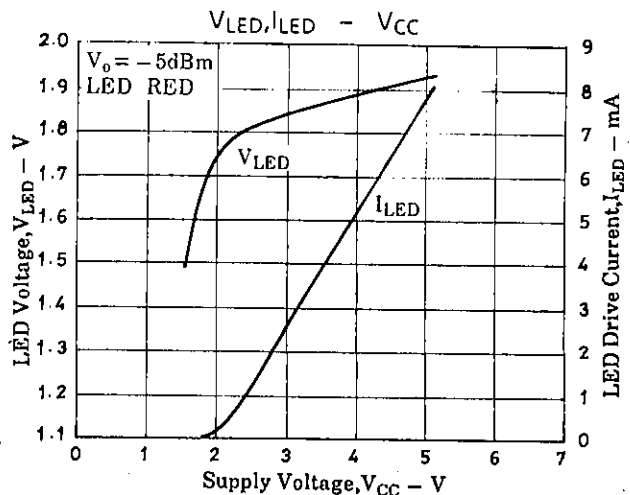
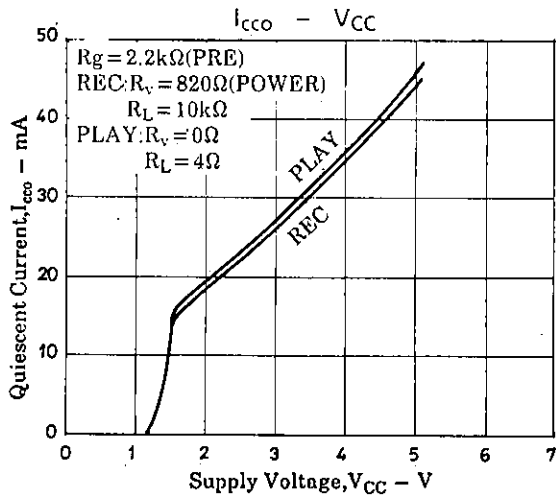

LA4165M

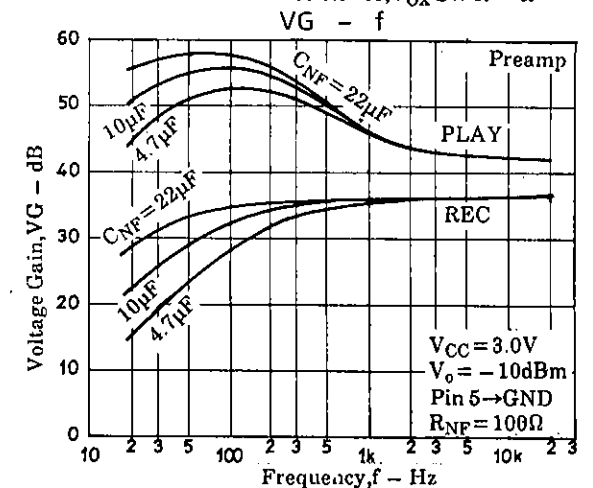
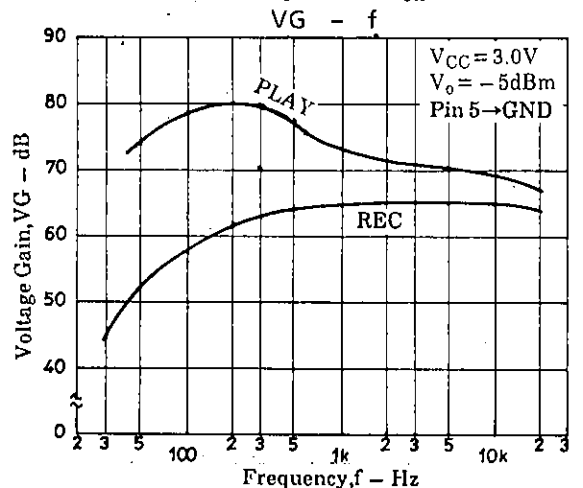
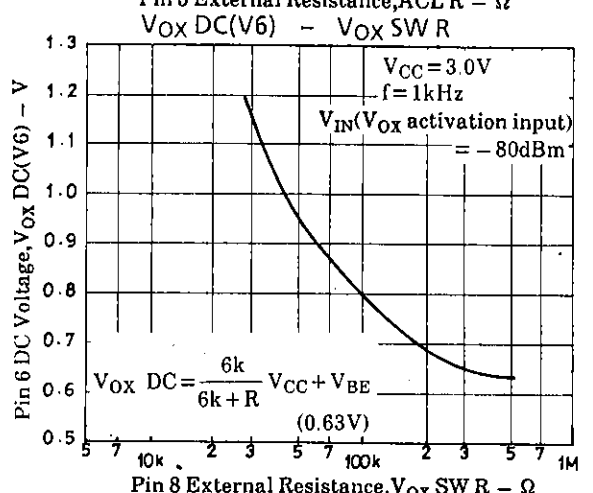
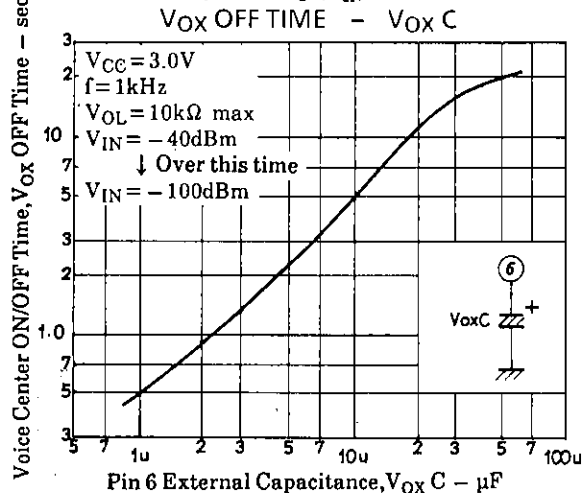
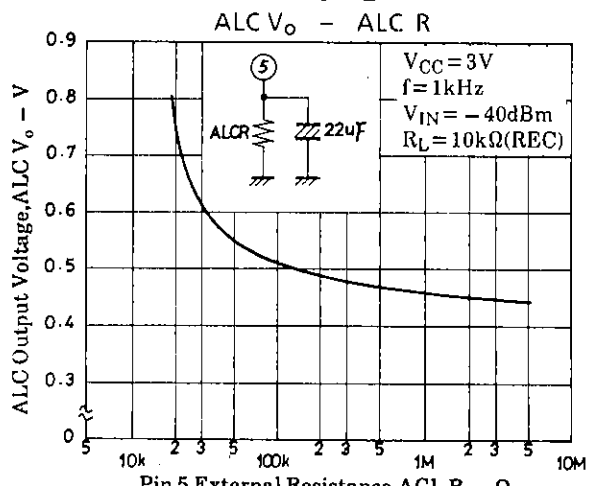
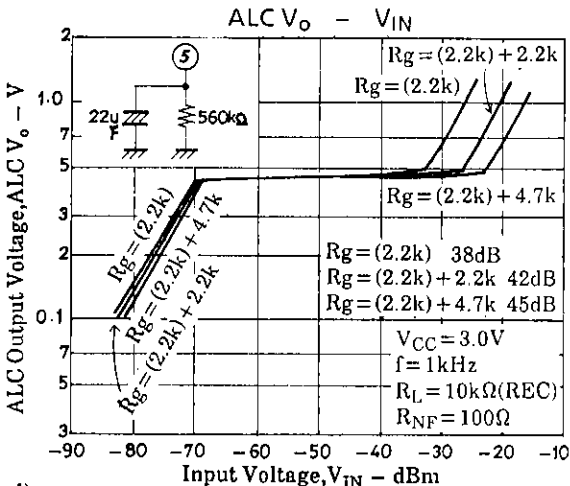
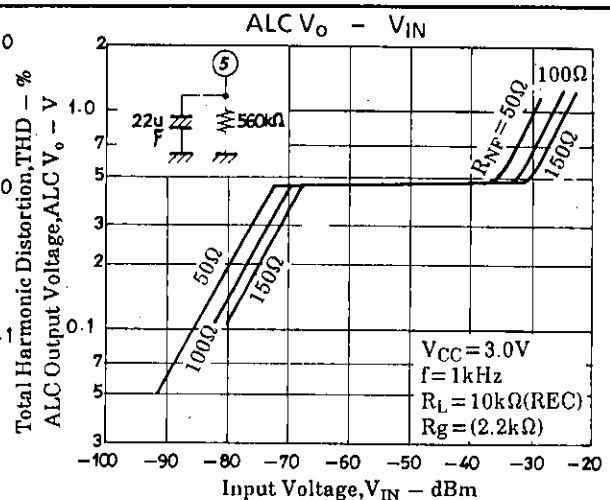
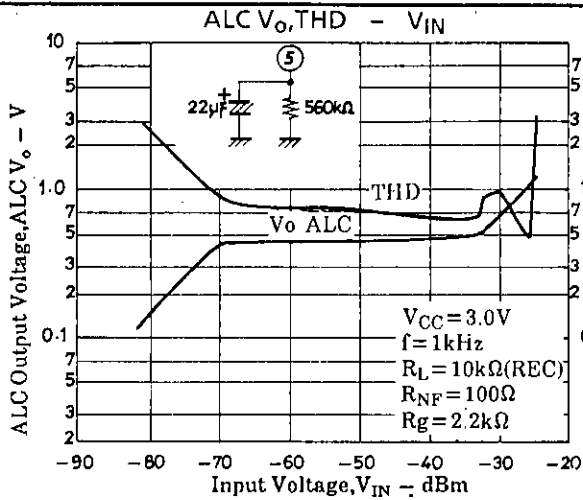

LA4165M

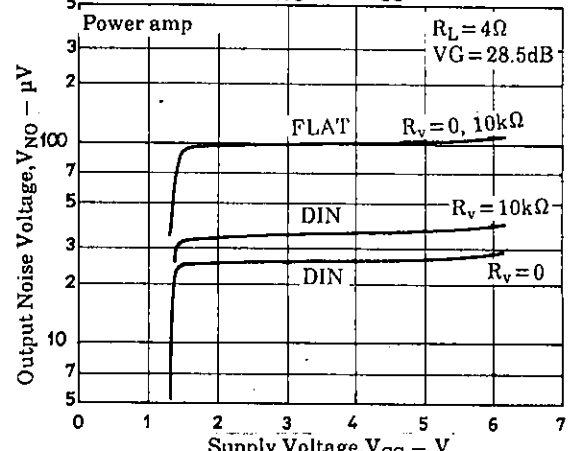
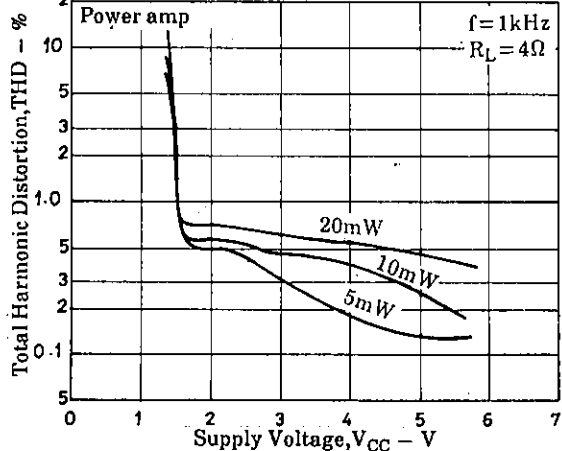
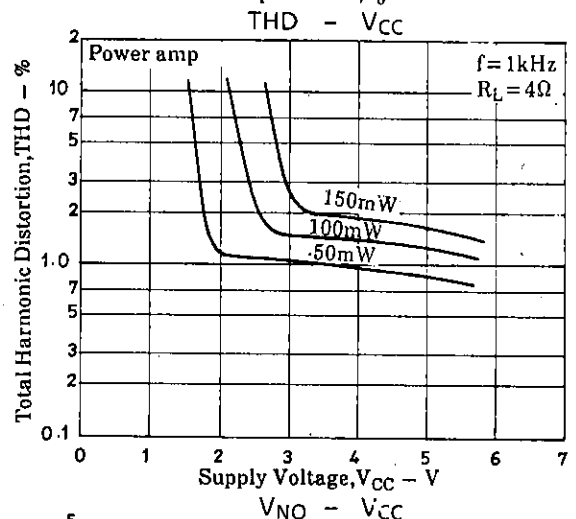
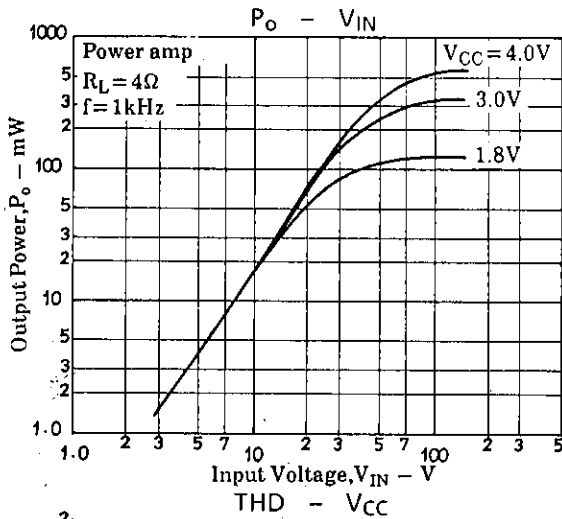
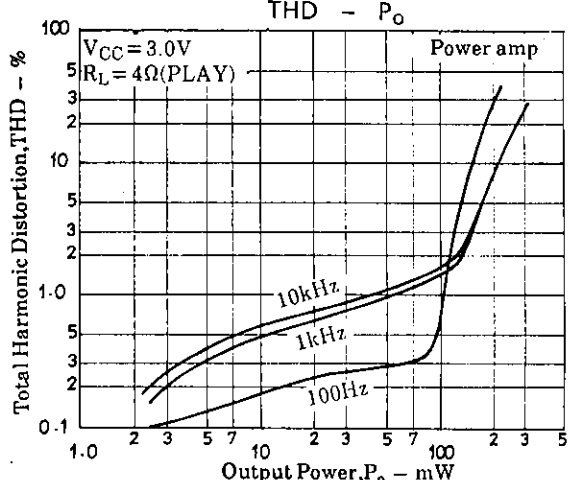
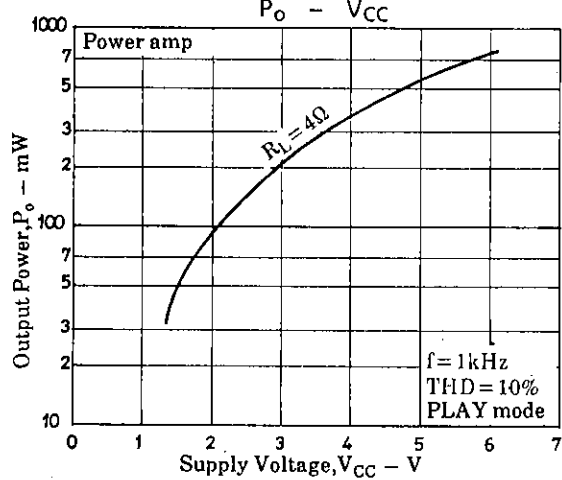
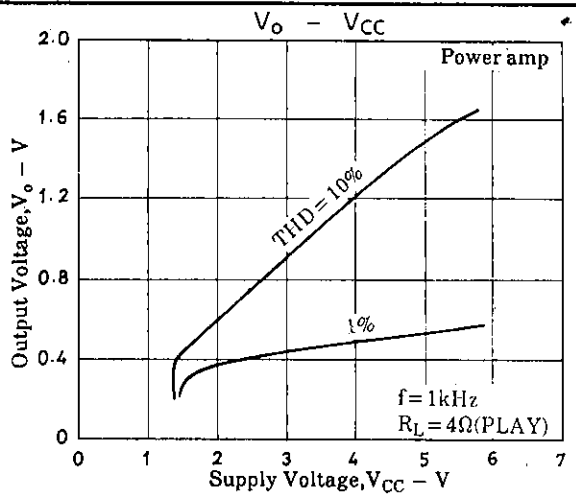
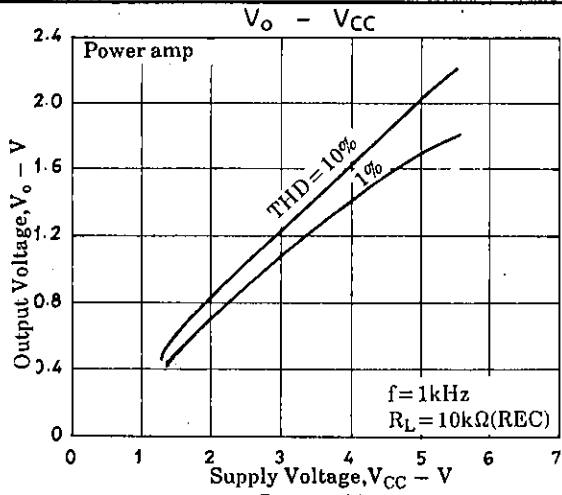

LA4165M

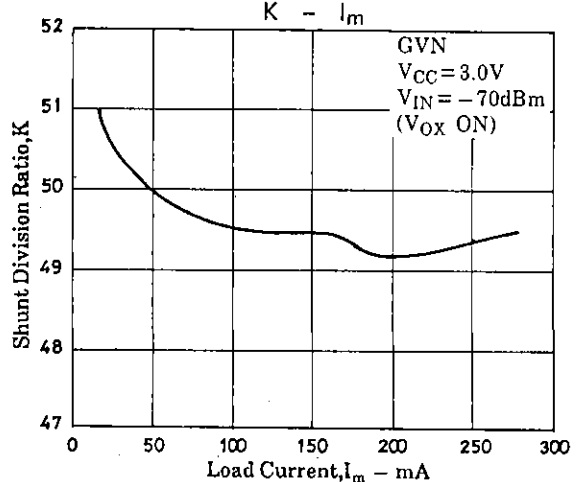
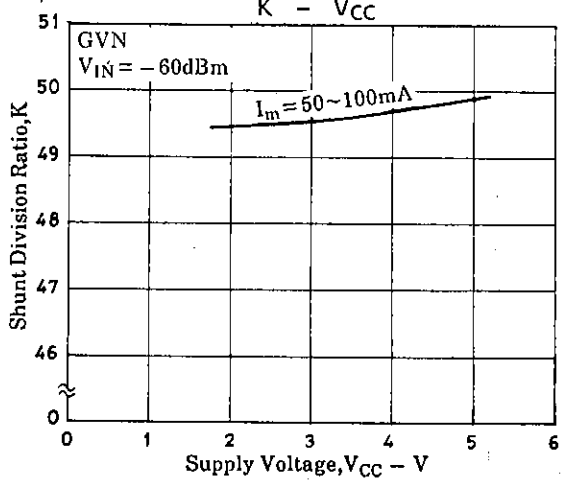
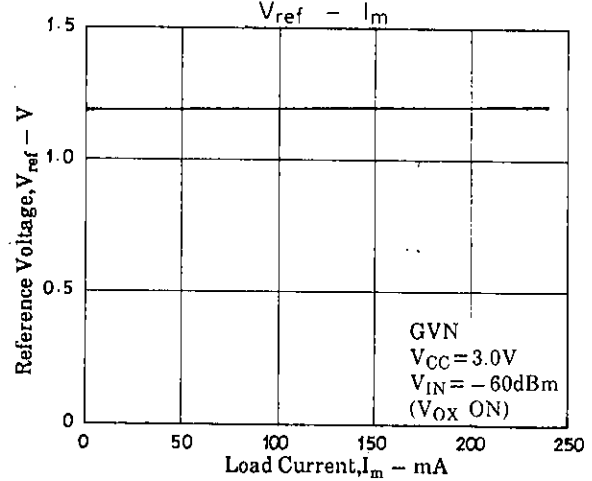
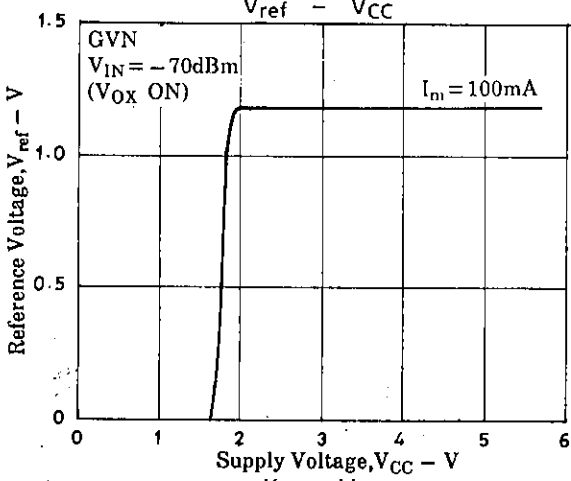
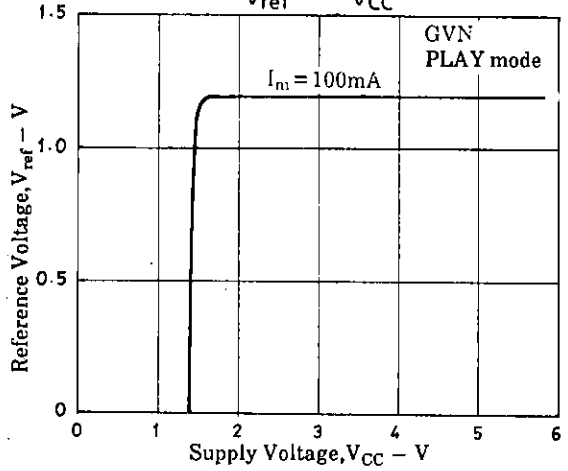
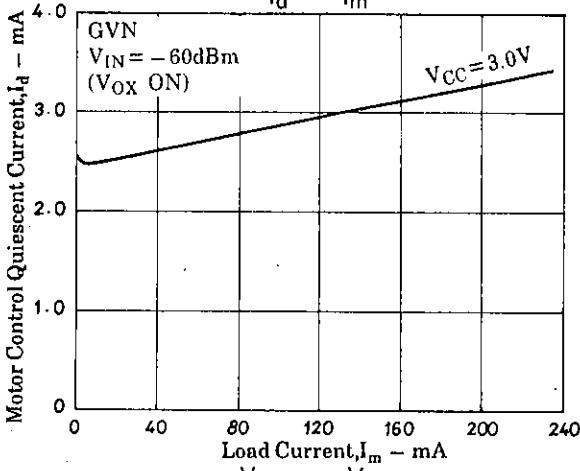
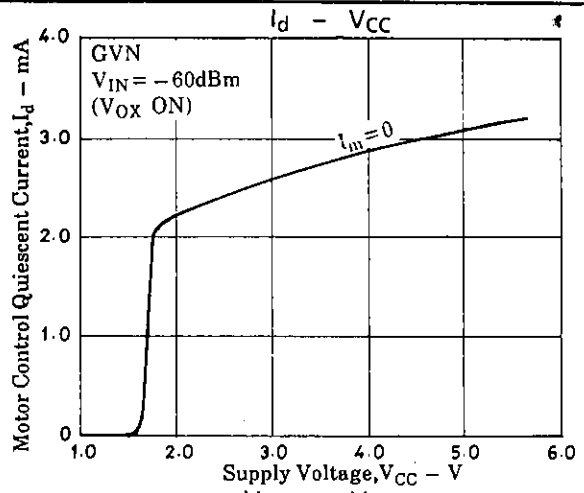
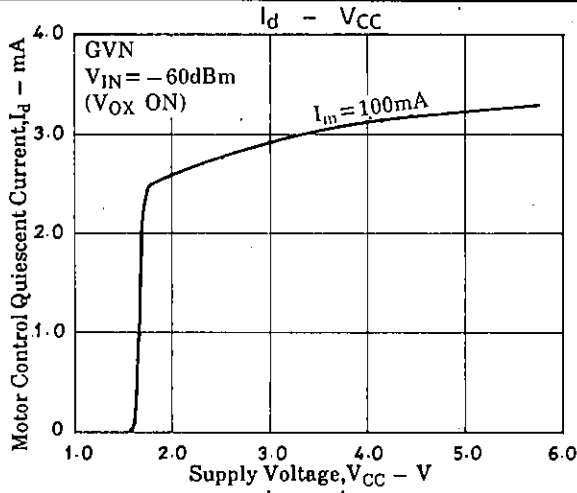

- No products described or contained herein are intended for use in surgical implants, life-support systems, aerospace equipment, nuclear power control systems, vehicles, disaster/crime-prevention equipment and the like, the failure of which may directly or indirectly cause injury, death or property loss.
- Anyone purchasing any products described or contained herein for an above-mentioned use shall:
 - ① Accept full responsibility and indemnify and defend SANYO ELECTRIC CO., LTD., its affiliates, subsidiaries and distributors and all their officers and employees, jointly and severally, against any and all claims and litigation and all damages, cost and expenses associated with such use;
 - ② Not impose any responsibility for any fault or negligence which may be cited in any such claim or litigation on SANYO ELECTRIC CO., LTD., its affiliates, subsidiaries and distributors or any of their officers and employees jointly or severally.
- Information (including circuit diagrams and circuit parameters) herein is for example only; it is not guaranteed for volume production. SANYO believes information herein is accurate and reliable, but no guarantees are made or implied regarding its use or any infringements of intellectual property rights or other rights of third parties.